

Messrs: Freescale ZigBee

Specification



Customer part number	-
Customer specification Number	-
Product	Quartz Crystal
Model	CX3225SB
Frequency	16000kHz
Part Number	CX3225SB16000E0FPZ25

Pb Free, RoHS Compliant

[STAMP]

Sales office
 KYOCERA Corporation
 (Electronic Components Sales Division)
 Head Office 6 Takeda Tobadono-cho, Fushimi-ku,
 Kyoto 612-8501 Japan
 TEL 075-604-3500
 FAX 075-604-3501

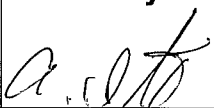
Production
 KYOCERA KINSEKI Corporation
 (Crystal Unit Sales Promotion Division)
 1-8-1, Izumi-honcho, Komae-Shi,
 Tokyo 201-8648 Japan
 TEL 03-5497-3111
 FAX 03-5497-3209

Design KYOCERA KINSEKI Yamagata Co. Crystal Units division	Issued by 	Approved by 
---	--	---

※Recycled paper is being used for the conservation of nature.

Date: 2007/12/21

Change History

Rev	DESCRIPTION	DATE	DRAWN	CHECKED	APPROVED
0	Preliminary spec release	2006/12/ 5	A. ITO	Y. TAKAHASHI	T. UETA
① ②	<ul style="list-style-type: none"> Part Number Change. CX3225SB16000E0FPZ09 ↓ CX3225SB16000E0FPZ21 	2006/12/13	A. ITO		Y. TAKAHASHI
③	<ul style="list-style-type: none"> Equivalent Series Resistance Change. 100 Ω → 60 Ω 				
④ ⑤	<ul style="list-style-type: none"> Part Number Change. CX3225SB16000E0FPZ21 ↓ CX3225SB16000E0FPZ25 	2007/12/21	<i>A. ITO</i>		<i>T. Ueta</i>
⑥	<ul style="list-style-type: none"> Equivalent Series Resistance change. 60 Ω → 54 Ω 				
⑦	<ul style="list-style-type: none"> Drive Level change. 0.01-0.1 mW → 0.01-100 μW 				

1. APPLICATION

This specification sheet is applied to quartz crystal "CX3225SB".

2. PART NUMBER

CX3225SB16000E0FPZ25

3. RATINGS

Items	SYMB.	Rating	Unit	Remarks
Operating Temperature	Topr	-40~+85	deg. C	
Storage Temperature range	Tstg	-40~+105	deg. C	

4. CHARACTERISTICS**ELECTRICAL CHARACTERISTICS**

Items	Electrical Specification					Test Condition	Remarks
	SYMB.	Min	Typ.	Max	Unit		
Mode of Vibration		Fundamental					
Nominal Frequency	F0		16		MHz		
Nominal Temperature	T _{NOM}		25		deg. C		
Load Capacitance	CL		9		pF		
Frequency Tolerance	df/F	-10.0		10.0	PPM	25±5°C Network Analyzer E5100A 200 μA	
Frequency Temperature characteristics	df/F	-16.0		16.0		-40~+85°C	
Frequency Ageing Rate		-1.0		1.0		1year	25±5°C
Equivalent Series Resistance	ESR			54	Ohms	Network Analyzer E5100A 200 μA	
Drive Level	Pd	0.01		100	μW		
Shunt Capacitance	C ₀		0.45		pF		
Motional Capacitance	C ₁		1.8		fF		
Insulation Resistance	IR	500			M ohms	100V(DC)	
Pullability			-15.1		ppm/pF		

Date: 2007/12/21

5. APPEARANCES, PHYSICAL DIMENSION OUTLINE DIMENSION (not to scale)

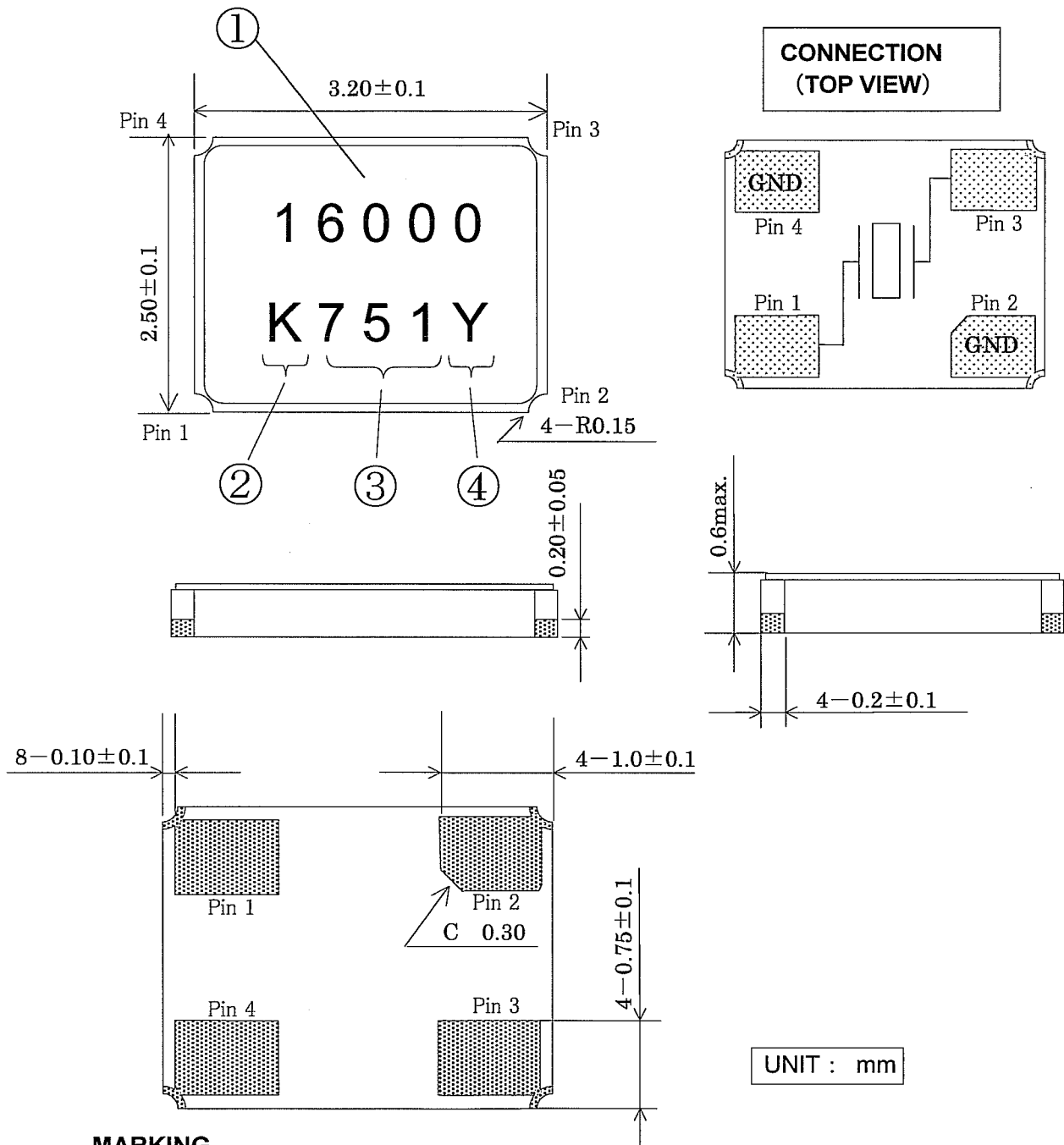

MARKING

- ① Nominal Frequency Move the number of maximum indication beams of the frequency to five digits, and omit less than kHz.
- ② Identification
- ③ Date Code Year...LAST 1 DIGIT of YEAR AND WEEK ※For details to P11
(Ex) December 21, 2007 → 751
- ④ Manufacturing Location
Y...Yamagata
Z...Shiga Yohkaich
T...Thailand

※The font of marking is reference.

Date: 2007/12/21

6. RECOMMENDED LAND PATTERN (not to scale)

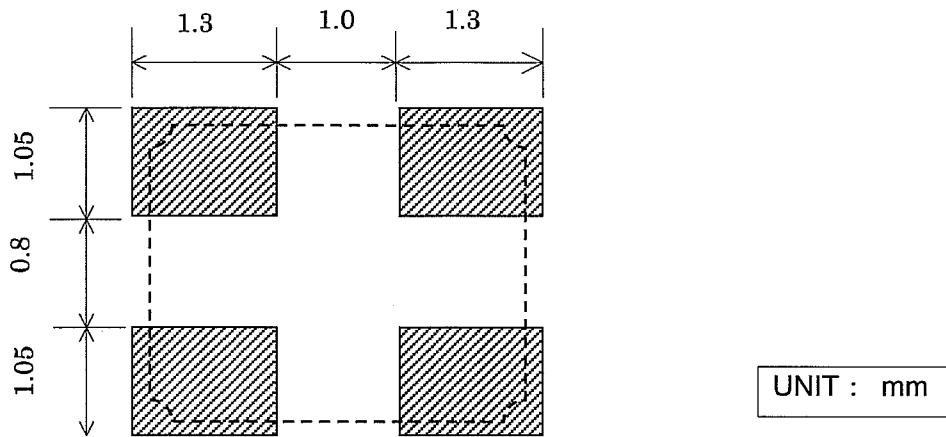

7. Quality Assurance

Location

Kyocera Kinseki Yamagata Corporation ... Kyocera Kinseki Yamagata

Quality Assurance Division

Kyocera Kinseki Corporation Shiga Yohkaichi Plant ... Kyocera Kinseki

Quality Assurance Division

Kyocera Kinseki (Thailand) Co., Ltd.: Kyocera Kinseki (Thailand) Co., Ltd

Quality Assurance Division

Quality guarantee

When the failure by the responsibility of our company occurs clearly after delivery within 1 year, a substitute article etc. is appropriated gratuitously and this is guaranteed. However, when passing 1 year after delivery, there is a case where I am allowed to consider as onerous repair after both consultation.

Date: 2007/12/21

8.TAPING & REEL

8-1.Dimensions (寸法図)

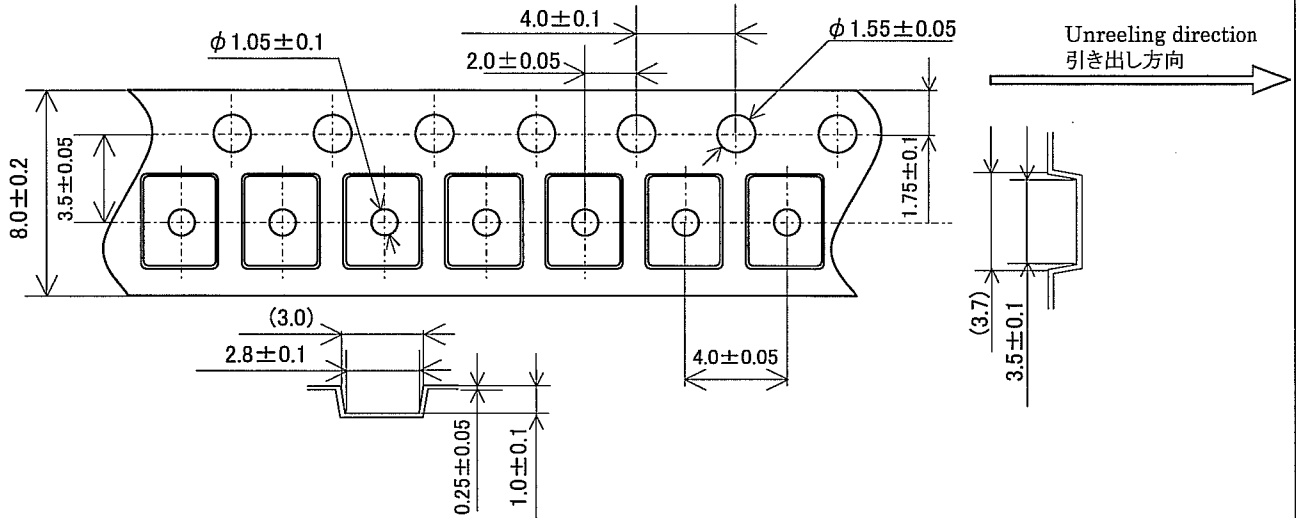

8-2.Leader and trailer tape (リーダー部テープ部及び終末端部テープ)

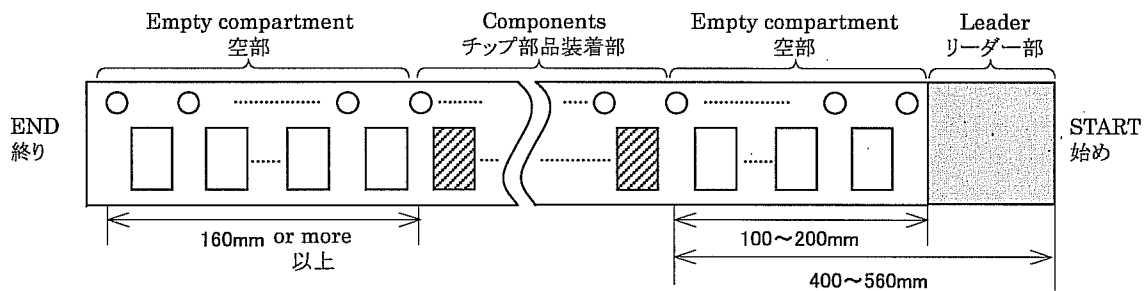

8-3.Direction (The direction shall be seen from the top cover tape side)

テーピング方向 (トップカバーテープ側から見る。)

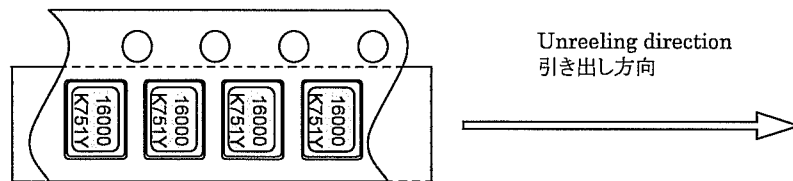

8-4.Specification (記事)

- Material of the carrier tape shall be polystyrene or A-PET (ESD).
{装着テープの材質は、PS もしくは A-PET とする。(静電対策品)}
- Material of the seal tape shall be polyester(ESD). {シールテープの材質はポリエステルとする。(静電対策品)}
- The seal tape shall not cover the sprocket holes. And not protrude from the carrier tape. {シールテープは送り穴をふさいだり、装着テープからはみ出していないこと。}
- Tensile strength of the tape : 10N or more. {テープの引張り強度は 10N 以上}
- The R of the corner without designation is 0.2RMAX. {指定無きコーナーの R は 0.2RMAX}
- Disalignment between centers of the cavity and sprocket hole shall be 0.05mm or less. {角穴の中心と送り穴の中心とのずれは、0.05mm 以下とする。}
- Cumulative pitch tolerance of "P₀" shall be ± 0.2 mm at 10 pitches. {"P₀"の累積ピッチ許容差は、10 ピッチで ± 0.2 mm とする。}
- Suppose that it unifies as shown in the above-mentioned figure to the directivity of printing in an embossing tape.
{エンボステープ内における印字の方向性は上記図のように統一することとする。}
- Peeling force of the seal tape: 0.3 to 0.7N. {シールテープ剥離強度 0.3~0.7N}

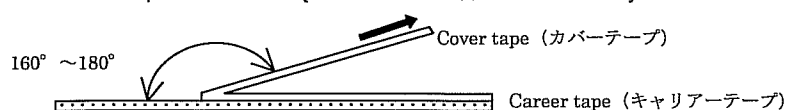

Date: 2007/12/21

Reel specifications

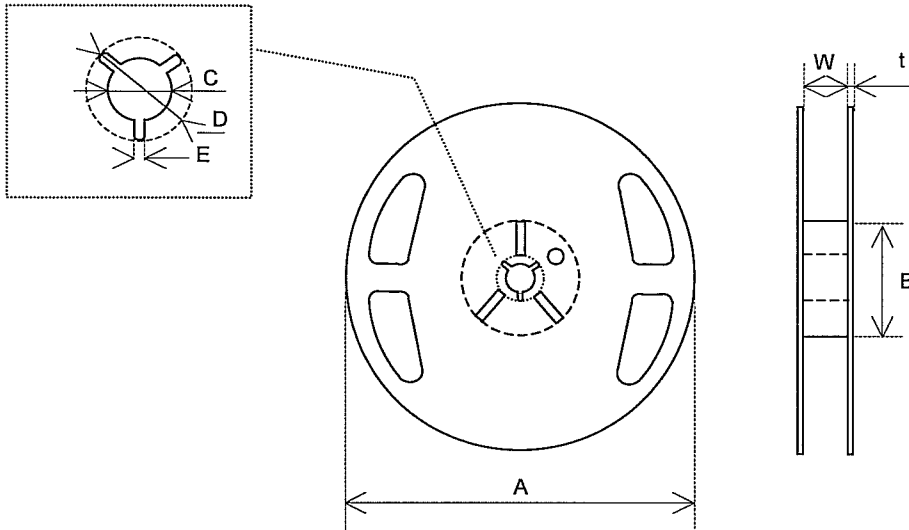

In the case of $\Phi 180$ Reel(1000 or 3000 pcs)

Symbol	A	B	C	D
Dimension	$\phi 180 +0/-3$	$\phi 60 +1/-0$	$\phi 13 \pm 0.2$	$\phi 21 \pm 0.8$
Symbol	E	W	t	
Dimension	2.0 ± 0.5	9 ± 1	2.0 ± 0.5	

(Unit : mm)

In the case of $\Phi 330$ Reel(1000 or 3000 or 5000 pcs)

Symbol	A	B	C	D
Dimension	$\phi 330 \pm 0.2$	$\phi 100 \pm 1.0$	$\phi 13 \pm 0.2$	$\phi 21 \pm 0.8$
Symbol	E	W	t	
Dimension	2.0 ± 0.5	13.5 ± 0.5	2.2 ± 0.1	

(Unit : mm)

Date: 2007/12/21

9.6 Resistance to Moisture

Test condition

The quartz crystal unit shall be stored at a temperature of $60 \pm 2^\circ\text{C}$ with relative humidity of 90% to 95% for 240 h. Then it shall be subjected to standard atmospheric conditions for 1h, after which measurements shall be made

9.7 Soldering condition

1.) Material of solder

Kind ... lead free solder paste

Melting point ... $220 \pm 5^\circ\text{C}$

2.) Temp.profile of reflow soldering system

	Temp [$^\circ\text{C}$]	Time[sec]
Peak	260 ± 5	10 (max.)
Preheating	180 (typ.)	100 (typ.)
Total	—	200 (max.)

Temp. profile of reflow

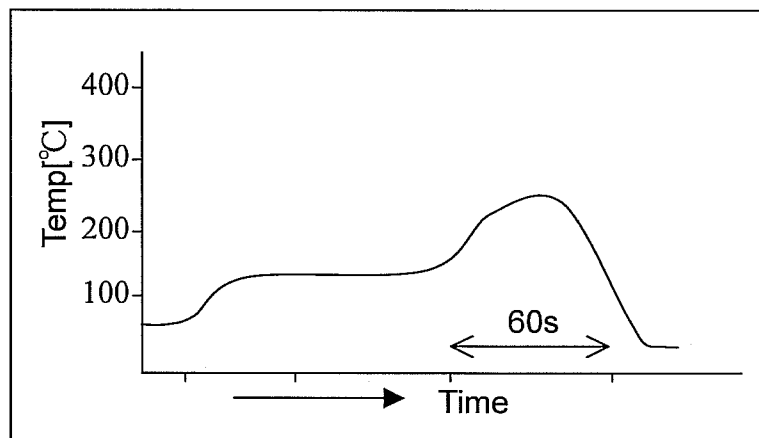

9.8 Intensity for bending in circuit board

Solder this product in center of the circuit board of $40\text{mm} \times 100\text{mm}$, and add the deflection of 3mm as the bottom figure.

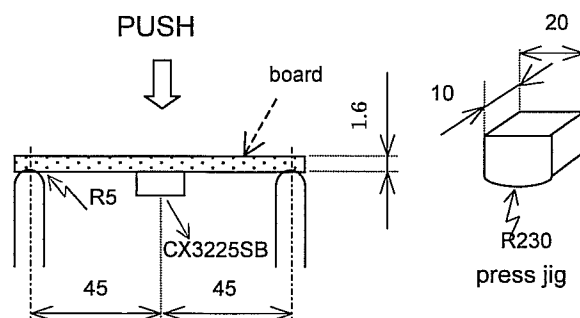
Test board : $t=1.6\text{mm}$ 

UNIT : mm

Date: 2007/12/21

10. Cautions for use**(1) Automatic mounting machine use**

Please use after affirmation that select the mounting machine model with a shock small if possible in the case of use of an automatic mounting machine, and it does not have breakage. There is a risk of a quartz crystal unit breakage occurring and not functioning normally by too much shock etc.

(2) Conformity of a circuit

In case of use of an oscillation circuit, please insert in a quartz crystal unit in series resistance 5 time as many as the standard value of equivalent in-series resistance, and confirm oscillating. Please remove resistance which inserted after the notes above-mentioned examination in the quartz crystal unit in series, and use it.

11. Storage conditions

Storage at prolonged high temperature or low temperature and the storage by high humidity cause degradation of frequency accuracy, and degradation of soldering nature. Storage is performed at the temperature of 18-30 degrees C, and the humidity of 20-70 Percent in the state of packing, and a term is 6 months.

12. Others

When any questions and opinions are in the written matter of these delivery specifications, I will ask connection of you from the our company issue day within 45 days. In a connection no case, a written matter is consented to it and employed within a term.

Date: 2007/12/21

13.LOT CALENDAR

WEEK	MONTH	SUN	MON	TUE	WED	THU	FRI	SAT	WEEK	MONTH	SUN	MON	TUE	WED	THU	FRI	SAT
週	月	日	月	火	水	木	金	土	週	月	日	月	火	水	木	金	土
0701	1		1	2	3	4	5	6	0728	7	8	9	10	11	12	13	14
0702		7	8	9	10	11	12	13	0729		15	16	17	18	19	20	21
0703		14	15	16	17	18	19	20	0730		22	23	24	25	26	27	28
0704		21	22	23	24	25	26	27	0731	8	29	30	31	1	2	3	4
0705	2	28	29	30	31	1	2	3	0732		5	6	7	8	9	10	11
0706		4	5	6	7	8	9	10	0733		12	13	14	15	16	17	18
0707		11	12	13	14	15	16	17	0734		19	20	21	22	23	24	25
0708		18	19	20	21	22	23	24	0735	9	26	27	28	29	30	31	1
0709	3	25	26	27	28	1	2	3	0736		2	3	4	5	6	7	8
0710		4	5	6	7	8	9	10	0737		9	10	11	12	13	14	15
0711		11	12	13	14	15	16	17	0738		16	17	18	19	20	21	22
0712		18	19	20	21	22	23	24	0739		23	24	25	26	27	28	29
0713		25	26	27	28	29	30	31	0740	10	30	1	2	3	4	5	6
0714	4	1	2	3	4	5	6	7	0741		7	8	9	10	11	12	13
0715		8	9	10	11	12	13	14	0742		14	15	16	17	18	19	20
0716		15	16	17	18	19	20	21	0743		21	22	23	24	25	26	27
0717		22	23	24	25	26	27	28	0744	11	28	29	30	31	1	2	3
0718	5	29	30	1	2	3	4	5	0745		4	5	6	7	8	9	10
0719		6	7	8	9	10	11	12	0746		11	12	13	14	15	16	17
0720		13	14	15	16	17	18	19	0747		18	19	20	21	22	23	24
0721		20	21	22	23	24	25	26	0748	12	25	26	27	28	29	30	1
0722	6	27	28	29	30	31	1	2	0749		2	3	4	5	6	7	8
0723		3	4	5	6	7	8	9	0750		9	10	11	12	13	14	15
0724		10	11	12	13	14	15	16	0751		16	17	18	19	20	21	22
0725		17	18	19	20	21	22	23	0752		23	24	25	26	27	28	29
0726		24	25	26	27	28	29	30	0753		30	31					
0727	7	1	2	3	4	5	6	7									

Date: 2007/12/21

WEEK	MONTH	SUN	MON	TUE	WED	THU	FRI	SAT		WEEK	MONTH	SUN	MON	TUE	WED	THU	FRI	SAT
週	月	日	月	火	水	木	金	土		週	月	日	月	火	水	木	金	土
0801	1			1	2	3	4	5		0828	7	6	7	8	9	10	11	12
0802		6	7	8	9	10	11	12		0829		13	14	15	16	17	18	19
0803		13	14	15	16	17	18	19		0830		20	21	22	23	24	25	26
0804		20	21	22	23	24	25	26		0831	8	27	28	29	30	31	1	2
0805	2	27	28	29	30	31	1	2		0832		3	4	5	6	7	8	9
0806		3	4	5	6	7	8	9		0833		10	11	12	13	14	15	16
0807		10	11	12	13	14	15	16		0834		17	18	19	20	21	22	23
0808		17	18	19	20	21	22	23		0835		24	25	26	27	28	29	30
0809	3	24	25	26	27	28	29	1		0836	9	31	1	2	3	4	5	6
0810		2	3	4	5	6	7	8		0837		7	8	9	10	11	12	13
0811		9	10	11	12	13	14	15		0838		14	15	16	17	18	19	20
0812		16	17	18	19	20	21	22		0839		21	22	23	24	25	26	27
0813		23	24	25	26	27	28	29		0840	10	28	29	30	1	2	3	4
0814	4	30	31	1	2	3	4	5		0841		5	6	7	8	9	10	11
0815		6	7	8	9	10	11	12		0842		12	13	14	15	16	17	18
0816		13	14	15	16	17	18	19		0843		19	20	21	22	23	24	25
0817		20	21	22	23	24	25	26		0844	11	26	27	28	29	30	31	1
0818	5	27	28	29	30	1	2	3		0845		2	3	4	5	6	7	8
0819		4	5	6	7	8	9	10		0846		9	10	11	12	13	14	15
0820		11	12	13	14	15	16	17		0847		16	17	18	19	20	21	22
0821		18	19	20	21	22	23	24		0848		23	24	25	26	27	28	29
0822		25	26	27	28	29	30	31		0849	12	30	1	2	3	4	5	6
0823	6	1	2	3	4	5	6	7		0850		7	8	9	10	11	12	13
0824		8	9	10	11	12	13	14		0851		14	15	16	17	18	19	20
0825		15	16	17	18	19	20	21		0852		21	22	23	24	25	26	27
0826		22	23	24	25	26	27	28		0853		28	29	30	31			
0827	7	29	30	1	2	3	4	5										